

[Chem. Pharm. Bull.]  
28(2) 529-534 (1980)

## Syntheses of 4-(3-Cyano-1-triazeno)pyridazine 1-Oxides and Related Compounds<sup>1)</sup>

SHOZO KAMIYA and MASAYUKI TANNO

National Institute of Hygienic Sciences<sup>2)</sup>

(Received August 20, 1979)

4-(3-Cyano-1-triazeno)pyridazine 1-oxides (IIIa—d), 3,6-dimethyl-4-(3-cyano-1-triazeno)pyridazine 2-oxide and 6-(3-cyano-1-triazeno)tetrazolo[1,5-*b*]pyridazine were synthesized by treating the corresponding azides with potassium cyanide, followed by acidification with hydrochloric acid.

4-(3-Cyano-1-triazeno)pyridazine 1-oxide potassium salts (IIa, IIb) gave pyridazine 1-oxides (Va, Vb) on treatment with a mixture of hydrochloric acid and ethanol, and on treatment with hydrochloric acid alone, they gave a mixture of 4-chloropyridazine 1-oxides (VIa, VIb) and 4-aminopyridazine 1-oxides (VIIa, VIIb).

The reaction of the cyanotriazene potassium salt (IIa) and hydroxylamine hydrochloride gave 4-[3-(N<sup>2</sup>-hydroxyamidino)-1-triazeno]pyridazine 1-oxide (X), and a similar compound (XIIa) was also prepared.

An azourethan, 3,6-dimethyl-4-[3-(ethoxycarbonyl)-1-triazeno]pyridazine 2-oxide (XIIb) and an azourea, 6-(3-carbamoyl-1-triazeno)tetrazolo[1,5-*b*]pyridazine (XV) were synthesized from the corresponding cyanotriazene potassium salts.

Arylazopyridazine 1-oxides (VIIIa—g) and 2-oxides (IXa, b) were synthesized by treating the cyanotriazene potassium salts (IIa—d, XI) with a mixture of 2-naphthol or diphenylamine and ethanol containing hydrochloric acid.

**Keywords**—4-(3-cyano-1-triazeno)pyridazine 1-oxide; 3,6-dimethyl-4-(3-cyano-1-triazeno)pyridazine 2-oxide; 6-(3-cyano-1-triazeno)tetrazolo[1,5-*b*]pyridazine; 4-[3-(N<sup>2</sup>-hydroxyamidino)-1-triazeno]pyridazine 1-oxide; 3,6-dimethyl-4-[3-(ethoxycarbonyl)-1-triazeno]pyridazine 2-oxide; 6-(3-carbamoyl-1-triazeno)tetrazolo[1,5-*b*]pyridazine; arylazopyridazine 1-oxides; arylazopyridazine 2-oxides; cyanotriazene potassium salts; antitumor activity

We previously reported a reaction of 4-azidopyridine 1-oxide with potassium cyanide to form an addition product.<sup>1)</sup> The crystal structure of the addition product was later determined by X-ray structure analysis to be 4-(3-cyano-1-triazeno)pyridazine 1-oxide potassium salt, in which the cyano group is attached to the terminal nitrogen of the azido group.<sup>3)</sup>

This paper describes syntheses of 4-(3-cyano-1-triazeno)pyridazine 1-oxides and related compounds.

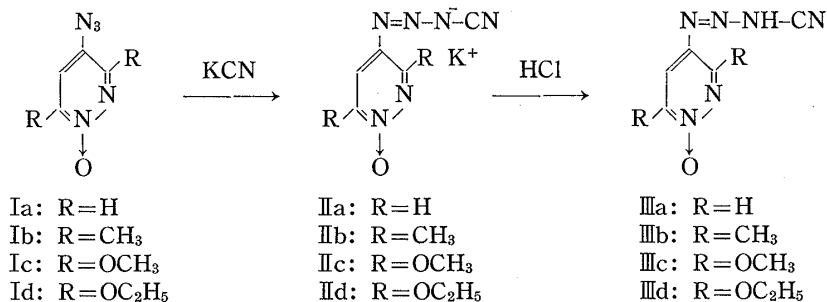

Chart 1

1) M. Tanno and S. Kamiya, *Chem. Pharm. Bull.*, **27**, 1824 (1979).

2) Location: 1-18-1 Kamiyoga, Setagaya, Tokyo 158, Japan.

3) T. Hata, S. Sato, T. Akiba, C. Tamura, M. Tanno, and S. Kamiya, Annual Meeting of the Chemical Society of Japan, Yokohama, April 1978, Abstracts I-588.

The starting materials, 4-azidopyridazine 1-oxides (Ia, Ib, Ic, Id) and 3,6-dimethyl-4-azidopyridazine 2-oxide were all synthesized directly by heating the corresponding 4-nitropyridazines with sodium azide in aqueous ethanol, in 80–95% yields. These azides were sensitive to light and exploded on rapid heating.

When solutions of Ia, Ib, Ic, and Id in aqueous ethanol were mixed with a solution of potassium cyanide, the corresponding 4-(3-cyano-1-triazeno)pyridazine 1-oxide potassium salts (IIa, IIb, IIc, IIId) were produced as yellow crystals in nearly quantitative yields. On acidification with hydrochloric acid they were converted to the free cyanotriazenes (IIIa, IIIb, IIIc, IIIId) (Chart 1). Their infrared spectra in nujol showed a cyano group absorption at 2230–2250  $\text{cm}^{-1}$ . The cyano groups in these cyanotriazenes should be bound to the terminal nitrogen of the azido group by analogy with 4-(3-cyano-1-triazeno)pyridine 1-oxide potassium salt, the structure of which was determined by X-ray structure analysis.<sup>3)</sup>

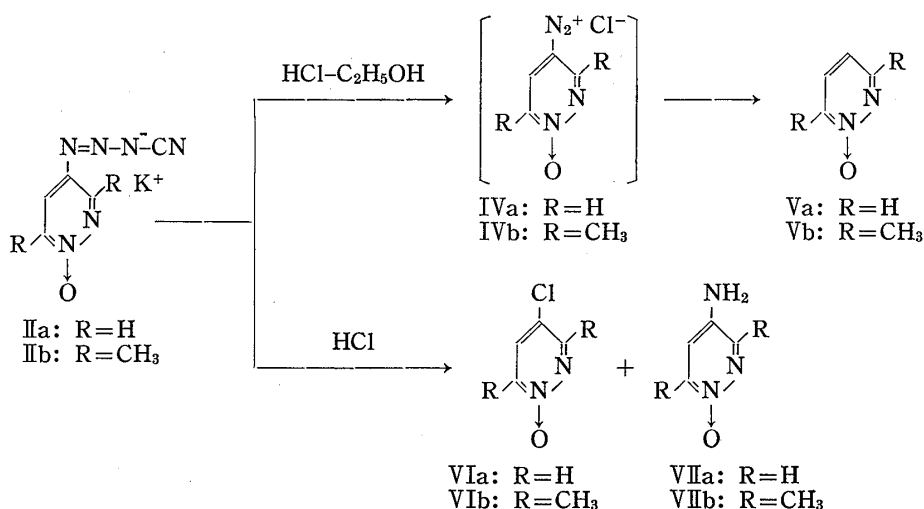

Chart 2

Several reactions of these 4-(3-cyano-1-triazeno)pyridazine 1-oxides were examined and new related compounds were obtained.

When IIa and IIb were warmed in ethanol containing a small amount of hydrochloric acid, pyridazine 1-oxide (Va) and 3,6-dimethylpyridazine 1-oxide (Vb) were obtained in 60% and 73% yields, respectively (Chart 2). Such elimination of the cyanotriazeno group suggests that the intermediates were the diazonium compounds (IVa, IVb), which were subsequently reduced with ethanol to give Va and Vb.

On the other hand, when IIa and IIb were heated with hydrochloric acid alone, they gave 4-chloropyridazine 1-oxides (VIa, VIb) and 4-aminopyridazine 1-oxides (VIIa, VIIb). Apparently, there is a prototropic tautomerism in the free cyanotriazene [ $-\text{N}=\text{N}-\text{NH}-\text{CN} \rightleftharpoons \text{NH}-\text{N}=\text{N}-\text{CN}$ ].

This ready formation of the diazonium compounds from the cyanotriazenes (IIa, IIb) in ethanol containing hydrochloric acid was successfully applied to the synthesis of 4-arylazopyridazine 1-oxides (VIIIa–g) and 2-oxides (IXa, b) which could not be obtained by a diazocoupling reaction of the corresponding 4-amino compounds (Table I).

Several reactions of the terminal cyano group of these cyanotriazenes were attempted, and the following two reactions gave readily isolable products. The reaction of IIa with hydroxylamine hydrochloride in ethanol gave 4-[3-(N<sup>2</sup>-hydroxyamidino-1-triazeno)pyridazine 1-oxide (X) in 72% yield. A similar reaction of 3,6-dimethyl-4-(3-cyano-1-triazeno)pyridazine 2-oxide potassium salt (XI) also gave the (N<sup>2</sup>-hydroxyamidino)triazeno derivative (XIIa) in 31% yield. When XI was warmed in ethanol containing a small amount of hydrochloric acid,

TABLE I. 4-Arylazopyridazine 1-Oxides (VIIIa—g)

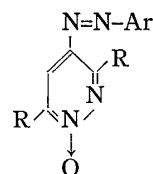

No.	R	Ar	Appearance	Recry- stalli- zation solvent	mp (°C) (dec.)	Yield (%)	Formula	Analysis (%)		
								Calcd (Found)	C	H
VIIIa	H		Red—purple plates	Ethanol	236—238	11	C <sub>14</sub> H <sub>10</sub> N <sub>4</sub> O <sub>2</sub>	63.15 (63.07)	3.79 (3.74)	21.04 (20.96)
VIIIb	H		Black—purple needles	Ethanol	230—231	36	C <sub>16</sub> H <sub>13</sub> N <sub>5</sub> O	65.97 (65.80)	4.50 (4.52)	24.04 (23.98)
VIIIc	CH <sub>3</sub>		Black—purple needles	Benzene	240	54	C <sub>16</sub> H <sub>14</sub> N <sub>4</sub> O <sub>2</sub>	65.29 (65.17)	4.80 (4.67)	19.40 (20.03)
VIII d	CH <sub>3</sub>		Black—purple needles	Ethanol	260—261	64	C <sub>18</sub> H <sub>17</sub> N <sub>5</sub> O	67.69 (67.12)	5.37 (5.46)	21.93 (21.32)
VIIIe	OCH <sub>3</sub>		Black—purple leaflets	Ethanol	220	18	C <sub>16</sub> H <sub>14</sub> N <sub>4</sub> O <sub>4</sub>	58.87 (58.65)	4.32 (4.25)	17.17 (17.15)
VIII f	OCH <sub>3</sub>		Black—purple needles	Benzene	226	32	C <sub>18</sub> H <sub>17</sub> N <sub>5</sub> O <sub>3</sub>	61.53 (61.80)	4.88 (4.90)	19.98 (19.66)
VIII g	OC <sub>2</sub> H <sub>5</sub>		Black—purple needles	Benzene	127—129	52	C <sub>20</sub> H <sub>21</sub> N <sub>5</sub> O <sub>3</sub>	63.31 (63.26)	5.58 (5.63)	18.46 (18.56)

4-Arylazopyridazine 2-Oxides (IXa, b)

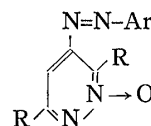

No.	R	Ar	Appearance	Recry- stalli- zation Solvent	mp (°C) (dec.)	Yield (%)	Formula	Analysis (%)		
								Calcd (Found)	C	H
IXa	CH <sub>3</sub>		Red—orange plates	Ethanol	242—243	20	C <sub>16</sub> H <sub>14</sub> N <sub>4</sub> O <sub>2</sub>	65.29 (65.17)	4.80 (4.63)	19.04 (19.06)
IXb	CH <sub>3</sub>		Black—purple plates	Ethanol	227—228	33	C <sub>18</sub> H <sub>17</sub> N <sub>5</sub> O	67.69 (67.24)	5.37 (5.37)	21.93 (21.24)

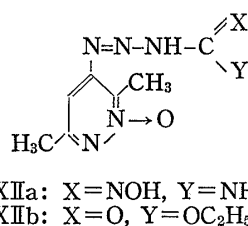
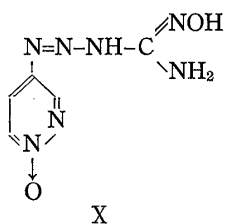

Chart 3

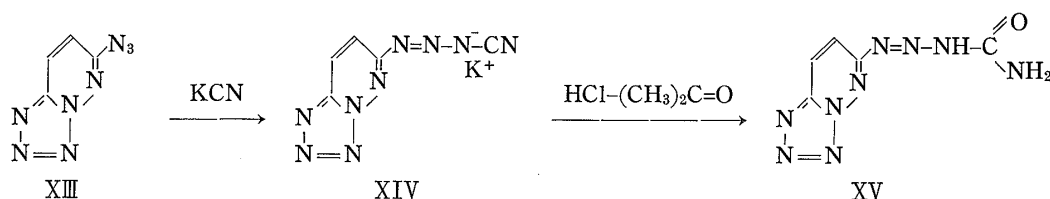

Chart 4

the product isolated was an azourea, 3,6-dimethyl-4-[3-(ethoxycarbonyl)-1-triazeno]pyridazine 2-oxide (XIIb), though the yield was only 16%.

6-Azidotetrazolo[1,5-*b*]pyridazine<sup>4)</sup> (XIII) also gave a cyanotriazene, 6-(3-cyano-1-triazeno)tetrazolo[1,5-*b*]pyridazine potassium salt (XIV). When XIV was warmed in acetone containing a small amount of hydrochloric acid at 50–60°, an azourea, 6-(3-carbamoyl-1-triazeno)tetrazolo[1,5-*b*]pyridazine (XV) was produced in 62% yield.

Although the nitrogen contents of some of these open-chain polynitrogen compounds (Chart 1, 2, 3, and 4) exceed 50%, they are surprisingly stable. They seem to exist as strong resonance hybrids involving the pyridazine ring and the polynitrogen residue.

The antitumor activities of these newly synthesized cyanotriazene potassium salts (IIa, IIb, IIc, IID) and their derivatives (XI, XIIa, XIIb) against rat ascites hepatoma AH-13 and mouse leukemia L-1210 were examined, but they were all ineffective.

#### Experimental<sup>5)</sup>

**4-Azidopyridazine 1-Oxides (Ia, Ib, Ic, Id)**—4-Azidopyridazine 1-oxide (Ia) has been prepared by treating 4-hydrazinopyridazine 1-oxide with nitrous acid.<sup>6)</sup> This time, these azides were directly synthesized by heating the corresponding 4-nitropyridazine 1-oxides with sodium azide. A typical experiment is described here for Ia. 4-Azidopyridazine 1-oxide (Ia): A mixture of 1.41 g (0.01 mol) of 4-nitropyridazine 1-oxide, 0.65 g (0.01 mol) of sodium azide and 150 ml of 50% aqueous ethanol was heated in a water bath for 5 hr. The reaction mixture was concentrated under reduced pressure, and extracted twice with CHCl<sub>3</sub>, then the CHCl<sub>3</sub> layer was dried over anhyd. Na<sub>2</sub>SO<sub>4</sub>. The CHCl<sub>3</sub> was distilled off and the residue was recrystallized from diisopropyl ether to give pale brown needles, mp 122–124° (dec.). [lit.,<sup>6)</sup> mp 123° (dec.)]. Yield, 1.20 g (88%).

3,6-Dimethyl-4-azidopyridazine 1-Oxide (Ib): Pale yellow needles (from ethanol), mp 140° (dec.). UV<sub>max</sub><sup>95% EtOH</sup> nm (log ε): 207 (4.01), 283 (4.21), 342 (3.95). IR  $\nu_{\max}^{\text{Nujol}}$  cm<sup>-1</sup>: 2160 (N<sub>3</sub>). Anal. Calcd for C<sub>6</sub>H<sub>7</sub>N<sub>5</sub>O: C, 43.63; H, 4.27; N, 42.41. Found: C, 43.31; H, 4.36; N, 42.59.

3,6-Dimethoxy-4-azidopyridazine 1-oxide (Ic): Reddish pillars (from ethanol), mp 89–91° (dec.) [lit.,<sup>7)</sup> mp 89–90° (dec.)].

3,6-Diethoxy-4-azidopyridazine 1-oxide (Id): Reddish needles (from a mixture of ethanol and diisopropyl ether), mp 80–81° (dec.). IR  $\nu_{\max}^{\text{Nujol}}$  cm<sup>-1</sup>: 2140 (N<sub>3</sub>). Yield, 98%. Anal. Calcd for C<sub>8</sub>H<sub>11</sub>N<sub>5</sub>O<sub>3</sub>: C, 42.66; H, 4.92; N, 31.10. Found: C, 42.73; H, 5.14; N, 31.39.

**4-(3-Cyano-1-triazeno)pyridazine 1-Oxides (IIIa, IIIb, IIIc, IIId)**—A typical experiment is described here for IIIa. 4-(3-Cyano-1-triazeno)pyridazine 1-oxide potassium salt (IIa): A solution of 0.65 g (0.01 mol) of potassium cyanide in 2 ml of water was added to a solution of 1.37 g (0.01 mol) of Ia in 50% aqueous ethanol with stirring, under ice-cooling. The reaction mixture was allowed to stand for 30 min. The precipitates that separated were filtered off and recrystallized from acetone. Yield, 1.25 g (91%). Yellow needles, mp 224–226° (dec.). IR  $\nu_{\max}^{\text{Nujol}}$  cm<sup>-1</sup>: 2170 (N=N-NKCN). Anal. Calcd for C<sub>5</sub>H<sub>3</sub>KN<sub>6</sub>O: C, 29.69; H, 1.49; N, 41.56. Found: C, 29.08; H, 1.75; N, 41.68. 4-(3-Cyano-1-triazeno)pyridazine 1-oxide (IIIa): A mixture of 0.40 g (0.002 mol) of IIa and 6 ml of 10% hydrochloric acid was allowed to stand for 30 min with occasional stirring. The precipitates that separated were filtered off and washed with ice-water, then with methanol.

4) T. Itai and S. Kamiya, *Chem. Pharm. Bull.*, **11**, 348 (1963).

5) The following instruments were used to obtain physical data: IR spectra, JASCO IR-S spectrophotometer; UV spectra, Shimadzu UV 210 double-beam spectrophotometer; NMR spectra, Varian 360A and JEOL 60 spectrometers (with tetramethylsilane as an internal standard); mass spectra, JEOL-01 SG-2 spectrometer. All melting points are uncorrected.

6) T. Itai and S. Kamiya, *Chem. Pharm. Bull.*, **11**, 1059 (1963).

7) T. Itai and S. Kamiya, *Chem. Pharm. Bull.*, **11**, 1073 (1963).

Yellow powder, mp  $>300^\circ$ . IR  $\nu_{\max}^{\text{Nujol}}$   $\text{cm}^{-1}$ : 2230 (N=N-NHCN). *Anal.* Calcd for  $\text{C}_5\text{H}_4\text{N}_6\text{O} \cdot 1/2\text{H}_2\text{O}$ : C, 34.68; H, 2.89; N, 48.55. Found: C, 34.77; H, 2.63; N, 48.56.

**3,6-Dimethyl-4-(3-cyano-1-triazeno)pyridazine 1-Oxide (IIIb):** Potassium salt (IIb): Yellow needles, mp  $252^\circ$  (dec.). Yield, 86%. UV $_{\max}^{95\% \text{ EtOH}}$  nm (log  $\epsilon$ ): 223 (3.76), 265 (3.50), 325 (3.97), 3.92 (4.33). IR  $\nu_{\max}^{\text{Nujol}}$   $\text{cm}^{-1}$ : 2180 (N=N-NKCN). *Anal.* Calcd for  $\text{C}_7\text{H}_7\text{KN}_6\text{O}$ : C, 36.50; H, 3.06; N, 36.49. Found: C, 36.51; H, 2.88; N, 36.30. Free cyanotriazene (IIIb): Pale yellow needles (from ethanol), mp  $120^\circ$  (dec.). IR  $\nu_{\max}^{\text{Nujol}}$   $\text{cm}^{-1}$ : 2250 (N=N-NHCN). *Anal.* Calcd for  $\text{C}_7\text{H}_8\text{N}_6\text{O}$ : C, 43.75; H, 4.20; N, 43.73. Found: C, 43.60; H, 4.18; N, 44.32.

**3,6-Dimethoxy-4-(3-cyano-1-triazeno)pyridazine 1-Oxide (IIIc):** Potassium salt (IIc): Canary yellow needles (from ethanol), mp  $198^\circ$  (dec.). Yield, 73%. UV $_{\max}^{95\% \text{ EtOH}}$  nm (log  $\epsilon$ ): 250 (3.86), 320 (3.83), 415 (4.44). IR  $\nu_{\max}^{\text{Nujol}}$   $\text{cm}^{-1}$ : 2160 (N=N-NKCN). Free cyanotriazene (IIIc): Orange granules (from ethanol), mp  $89^\circ$  (dec.). UV $_{\max}^{95\% \text{ EtOH}}$  nm (log  $\epsilon$ ): 250 (3.69), 325 (3.63), 415 (4.12). IR  $\nu_{\max}^{\text{Nujol}}$   $\text{cm}^{-1}$ : 2230 (N=N-NHCN). NMR (DMSO- $d_6$ ,  $\delta$ ): 3.97 (s,  $\text{OCH}_3$ ), 4.06 (s,  $\text{OCH}_3$ ).

**3,6-Diethoxy-4-(3-cyano-1-triazeno)pyridazine 1-Oxide (IIIId):** Potassium salt (IIId): Yellow needles (from ethanol), mp  $203^\circ$  (dec.). Yield, 81%. IR  $\nu_{\max}^{\text{Nujol}}$   $\text{cm}^{-1}$ : 2160 (N=N-NKCN). Free cyanotriazene (IIIId): Unstable crystals.

**Formation of Pyridazine 1-Oxides (Va, Vb) from 4-(3-Cyano-1-triazeno)pyridazine 1-Oxide Potassium Salts (IIa, IIb)**—A typical experiment is described here for IIb. A mixture of 0.23 g (0.01 mol) of IIb, 30 ml of ethanol and 2 ml of conc. hydrochloric acid was heated on a water bath for 30 min. The reaction mixture was concentrated under reduced pressure, then the residue was neutralized with sodium carbonate, and extracted with  $\text{CHCl}_3$  several times. The combined  $\text{CHCl}_3$  extracts were dried over anhyd.  $\text{Na}_2\text{SO}_4$  and the  $\text{CHCl}_3$  was distilled off. The IR spectrum of the residue was identical with that of authentic 3,6-dimethylpyridazine 1-oxide (Vb). Yield, 0.09 g (73%).

Similar treatment of IIa gave a 60% yield of pyridazine 1-oxide (Va), mp  $38\text{--}40^\circ$ .

**Formation of 4-Chloropyridazine 1-Oxides (VIa, VIb) and 4-Aminopyridazine 1-Oxides (VIIa, VIIb) from 4-(3-Cyano-1-triazeno)pyridazine 1-Oxide Potassium Salts (IIa, IIb)**—A typical experiment is described here for IIb. A mixture of 0.23 g (0.001 mol) of IIb and 10 ml of conc. hydrochloric acid was heated in a water bath for 10 min. The reaction mixture was neutralized with sodium bicarbonate, and extracted with  $\text{CHCl}_3$  several times, then the combined extracts were dried over anhyd.  $\text{Na}_2\text{SO}_4$ . The  $\text{CHCl}_3$  was evaporated off, and the residue was recrystallized from diisopropyl ether to give colorless needles, mp  $131\text{--}132^\circ$ . This compound was identical with authentic 3,6-dimethyl-4-chloropyridazine 1-oxide<sup>8)</sup> (VIb) on the basis of mixed melting point determination. Yield, 0.06 g (38%). The water layer was evaporated to dryness under reduced pressure, then the residue was extracted with hot ethanol, and the ethanol was distilled off. The residue was recrystallized from ethanol to give colorless pillars, mp  $275^\circ$  (dec.), which were identical with authentic 3,6-dimethyl-4-aminopyridazine 1-oxide<sup>9)</sup> (VIIb) by IR spectroscopy. Yield, 0.08 g (58%).

Similar treatment of IIa gave a 2% yield of 4-chloropyridazine 1-oxide (VIa), mp  $117\text{--}118^\circ$  (lit.,<sup>10)</sup> mp  $119\text{--}121^\circ$  and a 29% yield of 4-aminopyridazine 1-oxide (VIIa), mp  $220\text{--}223^\circ$  (dec.) [lit.,<sup>11)</sup> mp  $222\text{--}224^\circ$  (dec.)].

**4-Arylazopyridazine 1-Oxides (VIIIa-g)**—A typical experiment is described here for IIa. A mixture of 0.202 g (0.001 mol) of IIa, 0.144 g (0.001 mol) of 2-naphthol, 10 ml of 70% aqueous ethanol and 0.5 ml of conc. hydrochloric acid was heated at  $80^\circ$  for 10 min. The crystals that separated were filtered off, and recrystallized from ethanol: reddish-purple plates, mp  $236\text{--}238^\circ$  (dec.). If the crystals did not separate, the solvent was evaporated off under reduced pressure and the residue was extracted several times with  $\text{CHCl}_3$ . The  $\text{CHCl}_3$  layer was dried over anhyd.  $\text{Na}_2\text{SO}_4$ , and the solvent was distilled off. The residue was dissolved in a mixture of benzene and ethanol (3:1) and the solution was passed through a Florisil column. The column was washed with the same solvent. Unreacted 2-naphthol was recovered from the first fraction and the azo compound was eluted subsequently. The physical and analytical data for these azo compounds are listed in Table I.

**3,6-Dimethyl-4-arylazopyridazine 2-Oxides (IXa, IXb)**—3,6-Dimethyl-4-azidopyridazine 2-Oxide: A mixture of 1.69 g (0.01 mol) of 3,6-dimethyl-4-nitropyridazine 2-oxide,<sup>11)</sup> 0.73 g (0.011 mol) of sodium azide and 25 ml of 50% aqueous ethanol was heated to boiling for 30 min. The reaction mixture was concentrated under reduced pressure, then the residue was extracted with  $\text{CHCl}_3$ , and the combined  $\text{CHCl}_3$  extracts were dried over anhyd.  $\text{Na}_2\text{SO}_4$ . The  $\text{CHCl}_3$  was distilled off and the residue was recrystallized from diisopropyl ether to give colorless needles, mp  $108\text{--}109^\circ$  (dec.). UV $_{\max}^{95\% \text{ EtOH}}$  nm (log  $\epsilon$ ): 235 (4.07), 250 (4.21), 323 (3.67). IR  $\nu_{\max}^{\text{Nujol}}$   $\text{cm}^{-1}$ : 2175 ( $\text{N}_3$ ). *Anal.* Calcd for  $\text{C}_6\text{H}_7\text{N}_5\text{O}$ : C, 43.63; H, 4.27; N, 42.41. Found: C, 43.64; H, 4.20; N, 42.50. This compound was also prepared by the reaction of nitrous acid and 3,6-dimethyl-4-hydrazinopyridazine 2-oxide, colorless prisms, mp  $223\text{--}224^\circ$ , which could itself be obtained

8) S. Sako, *Chem. Pharm. Bull.*, **11**, 337 (1963).

9) T. Nakagome, *Yakugaku Zasshi*, **82**, 253 (1962).

10) T. Itai and S. Natsume, *Chem. Pharm. Bull.*, **11**, 83 (1963).

11) T. Itai and S. Natsume, *Chem. Pharm. Bull.*, **12**, 228 (1964).

directly by heating 3,6-dimethyl-4-chloropyridazine 2-oxide and 80% hydrazine hydrate. *Anal.* Calcd for  $C_6H_{10}N_4O$ : C, 46.74; H, 6.54; N, 36.34. Found: C, 46.69; H, 6.40; N, 36.63.

**3,6-Dimethyl-4-(3-cyano-1-triazeno)pyridazine 2-Oxide Potassium Salt (XI):** This compound and the free cyanotriazene were prepared in the same way as the corresponding 1-oxides. Potassium salt (XI): Yellow needles, mp 215—216° (dec.).  $UV_{\max}^{95\% EtOH}$  nm (log  $\epsilon$ ): 275 (4.21), 364 (4.37). IR  $\nu_{\max}^{Nujol}$   $cm^{-1}$ : 2230 (N=N-NKCN). *Anal.* Calcd for  $C_7H_4KN_6O$ : C, 36.51; H, 3.06; N, 36.50. Found: C, 37.01; H, 3.02; N, 36.88. Free cyanotriazene: Colorless powder, mp 156—158° (dec.).  $UV_{\max}^{95\% EtOH}$  nm (log  $\epsilon$ ): 272 (4.24), 356 (4.22). IR  $\nu_{\max}^{Nujol}$   $cm^{-1}$ : 2240 (CN). *Anal.* Calcd for  $C_7H_5N_6O$ : C, 43.75; H, 4.20; N, 43.73. Found: C, 43.28; H, 4.04; N, 43.83.

**3,6-Dimethyl-4-(2-hydroxy-1-naphthyl)azopyridazine 2-oxide (IXa)** and **3,6-dimethyl-4-(4-anilinophenyl)azopyridazine 2-oxide (IXb)** were prepared in the same way as the corresponding 1-oxides (VIII) (Table I).

**4-[3-(N<sup>2</sup>-Hydroxyamidino)-1-triazeno]pyridazine 1-Oxide (X)**—A mixture of 0.20 g (0.001 mol) of IIa, 20 ml of methanol and 0.70 g (0.001 mol) of hydroxylamine hydrochloride was heated at 70—80° for 10 min. The crystals that separated were filtered and recrystallized from aqueous methanol. Yellow needles, mp 216—217° (dec.). Yield, 0.14 g (72%). IR  $\nu_{\max}^{Nujol}$   $cm^{-1}$ : 960 (=NOH). *Anal.* Calcd for  $C_5H_7N_7O_2$ : C, 30.46; H, 3.58; N, 49.73. Found: C, 30.59; H, 3.57; N, 48.95.

**3,6-Dimethyl-4-[3-(N<sup>2</sup>-hydroxyamidino)-1-triazeno]pyridazine 2-Oxide (XIIa):** Yellow prisms (from aqueous methanol), mp 193—194° (dec.). Yield, 31%. IR  $\nu_{\max}^{Nujol}$   $cm^{-1}$ : 950 (=NOH). *Anal.* Calcd for  $C_7H_{11}N_7O_2 \cdot 1/3H_2O$ : C, 36.33; H, 5.05; N, 42.38. Found: C, 36.84; H, 4.96; N, 42.04.

**3,6-Dimethyl-4-[3-(ethoxycarbonyl)-1-triazeno]pyridazine 2-Oxide (XIIb)**—A mixture of 2.30 g (0.01 mol) of XI, 300 ml of ethanol and 7 ml of conc. hydrochloric acid was heated at 50—60° for 1 hr. The reaction mixture was concentrated under reduced pressure, and the residue was extracted with  $CHCl_3$ . The  $CHCl_3$  layer was dried over anhyd.  $Na_2SO_4$  and the  $CHCl_3$  was distilled off. The residue was recrystallized from acetone to give colorless plates, mp 198—200° (dec.). Yield, 0.33 g (16%). IR  $\nu_{\max}^{Nujol}$   $cm^{-1}$ : 1765 (CO). MS  $m/e$ : 239 ( $M^+$ ). *Anal.* Calcd for  $C_9H_{13}N_5O_3$ : C, 45.18; H, 5.48; N, 29.28. Found: C, 45.56; H, 5.57; N, 29.43.

**6-(3-Carbamoyl-1-triazeno)tetrazolo[1,5-*b*]pyridazine (XV)**—**6-(3-Cyano-1-triazeno)tetrazolo[1,5-*b*]pyridazine Potassium Salt (XIV):** A solution of 1.30 g (0.02 mol) of potassium cyanide in 4 ml of water was added to a solution of 3.24 g (0.02 mol) of 6-azidotetrazolo[1,5-*b*]pyridazine<sup>4)</sup> in 50% aqueous dioxane with stirring under ice-cooling, and the reaction mixture was allowed to stand for 30 min. The precipitates that separated were filtered off, and recrystallized from aqueous methanol. Yellow needles, mp >300°. Yield, 4.25 g (87%). IR  $\nu_{\max}^{Nujol}$   $cm^{-1}$ : 2200 (N=N-NKCN). *Anal.* Calcd for  $C_5H_2KN_9 \cdot H_2O$ : C, 24.48; H, 1.63; N, 51.41. Found: C, 24.81; H, 1.62; N, 51.10. Free cyanotriazene: Yellow powder, mp >300°. IR  $\nu_{\max}^{Nujol}$   $cm^{-1}$ : 2220 (N=N-NHCN). *Anal.* Calcd for  $C_5H_3N_9$ : C, 31.72; H, 1.58; N, 66.62. Found: C, 31.63; H, 1.43; N, 66.51.

**6-(3-Carbamoyl-1-triazeno)tetrazolo[1,5-*b*]pyridazine (XV):** A mixture of 0.50 g (0.002 mol) of XIV, 100 ml of acetone and 1 ml of conc. hydrochloric acid was heated at 50—60° for 5 min. The precipitates that separated were filtered off and the filtrate was concentrated under reduced pressure. The residue was recrystallized from ethanol to give colorless needles, mp >300°. Yield, 0.26 g (62%). IR  $\nu_{\max}^{Nujol}$   $cm^{-1}$ : 3470, 3300, 1725 ( $-NHCONH_2$ ). *Anal.* Calcd for  $C_5H_5N_9O$ : C, 28.99; H, 2.43; N, 60.86. Found: C, 28.97; H, 2.32; N, 60.90.