

Hydrolysis of Spiro Derivatives that Undergo No Shrinkage on Polymerization

HirotaKa TAGOSHIt and Takeshi ENDO*

Research Laboratory of Resources Utilization, Tokyo Institute of Technology,
Nagatsuta-cho, Midori-ku, Yokohama 227

[†]Oita Research Laboratory, Showa Denko K. K., 2 Nakanosu, Oita-shi 870-01

(Received June 4, 1988)

Synopsis. Acid-catalyzed hydrolyses of spiroorthoesters (**1**, **2a**, **2b**, and **2c**) and spiroorthocarbonates (**3** and **4**) were carried out to give the corresponding ring-opening reaction products. The ring-cleavage modes of these spiro derivatives depended on the structure of intermediate cations.

Cationic ring-opening polymerization of spiroorthoesters (SOE)^{1,2} and spiroorthocarbonates (SOC),³⁻⁶ which undergo no shrinkage in volume on polymerization, affords the poly(ester-ether)s and poly(carbonate-ether)s, respectively. Radical ring-opening polymerization, and polyaddition of unsaturated spiroorthoesters (USOE)⁷ or spiroorthocarbonates (USOC)⁸ have been reported. Although, each of SOE, SOC, USOE, and USOC is rather labile to moisture, there is few report on the hydrolysis of them, i.e. hydrolysis of cyclic dialkoxy orthoesters by Deslongchamps and et al.¹³ and that of benzospiroorthoesters via dialkoxycarbocation intermediate by McClelland and Moreau.¹⁴

In this paper, we describe hydrolyses of some spiro derivatives in order to demonstrate the stability of these spiro monomers to water, and to clear the ring-cleavage mode of USOE and USOC.

Results and Discussion

As indicated in Scheme 1, there are two possible modes (a and b) of decomposition of intermediates (**6a** and **6b**) producing hydroxy esters **7a**, **7b**, and lactone **8** in hydrolysis of SOE. Actually, the mixture of **7a** and **7b** was obtained by the hydrolysis of SOE **1**, but **8** not at all. This result shows that the reaction proceeds via mode a only and further lactonization of the produced hydroxy esters does not occur.

In the hydrolysis of USOE **2**, there are two possible initial intermediates **9** and **13**. The former may give hydroxy ester **12**, and the latter, ester **16** via mode a (Scheme 2). The exclusive formation of **12** (Table 1) suggests that the intermediate **9** is more stable than **13** because of conjugate structure of cation.

There are two possible modes of decomposition of intermediate **11** which eventually affords **12** via mode a or lactone **17** and hydroxyacetone **18** via mode b. The hydrolysis of **2a** produced immediately corresponding **12a** accompanied by large amount of **17a**. **12a** can give the lactone under the similar conditions, but this

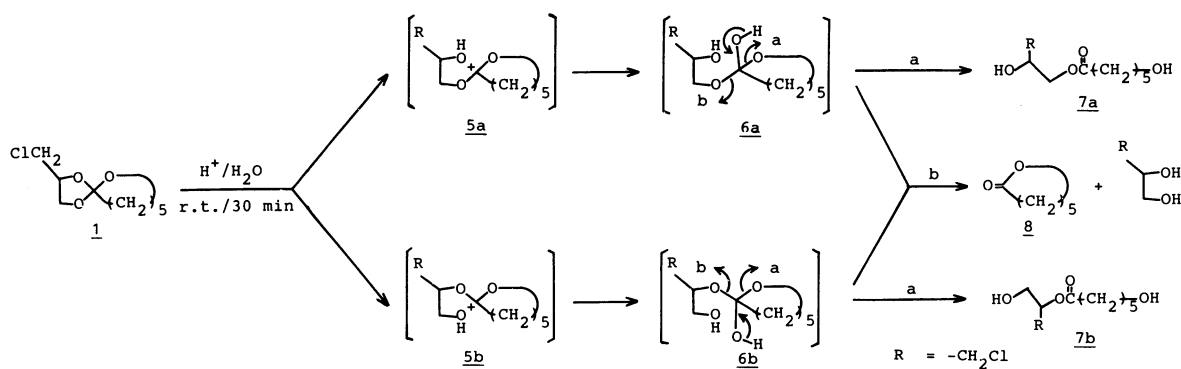

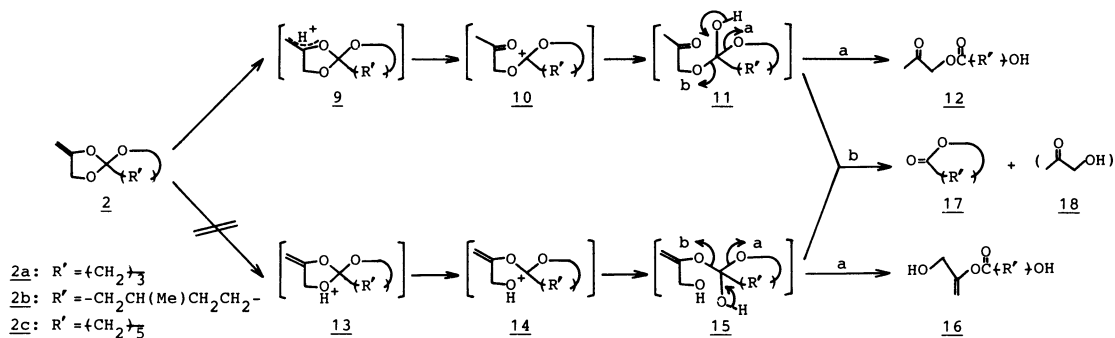

Scheme 1.

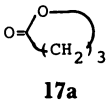

Scheme 2.

Table 1. Acid-Catalyzed Hydrolysis of Unsaturated Spiroorthoesters^{a)}

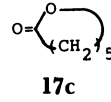
Unsaturated spiroorthoester	Reaction time	Products ^{b)}			
		Hydroxy ester	Yield/%	Lactone	Yield/%
2a	10 min	$\text{CH}_3\overset{\text{O}}{\parallel}\text{CCH}_2\text{OC}(\overset{\text{O}}{\parallel}\text{C}(\text{CH}_2)_3\text{OH})$ 12a	15	 17a	57
2b	60 min	$\text{CH}_3\overset{\text{O}}{\parallel}\text{CCH}_2\text{OC}(\overset{\text{O}}{\parallel}\text{C}(\text{CH}_2)\overset{\text{Me}}{\text{C}}\text{HCH}_2\text{CH}_2\text{OH})$ 12b	74	 17b	Trace
	20 h		0	17b	100
2c	20 h	$\text{CH}_3\overset{\text{O}}{\parallel}\text{CCH}_2\text{OC}(\overset{\text{O}}{\parallel}\text{C}(\text{CH}_2)_3\text{OH})$ 12c	63	 17c	0

a) Hydrolysis proceeded in THF/H₂O (4/1 in volume) at ambient temperature. b) Isolated yield.

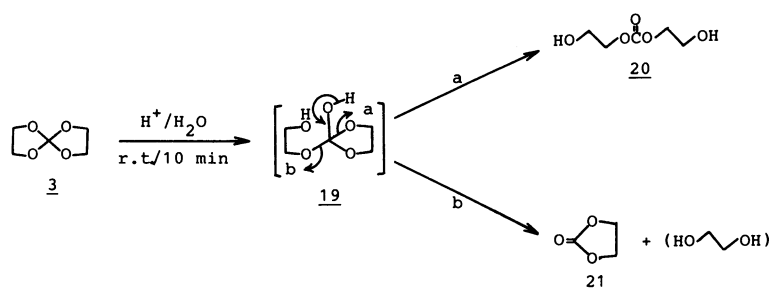

Scheme 3.

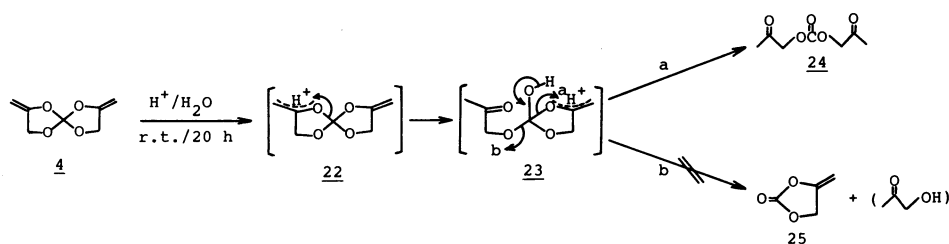

Scheme 4.

process is relatively slow.¹⁵⁾ Therefore, the hydrolysis of **2a** proceeds via both modes a and b. The hydrolysis of **2b** initially (60 min) gave the corresponding hydroxy ester **12b**, but finally (20 h) lactone **17b** quantitatively. Meanwhile, the hydrolysis of **2c** produced only **12c**. In conclusion, the mode of the hydrolysis of USOE including subsequent lactonization depends upon the structure (possibly upon the ring size) of spiro derivatives.

The hydrolysis of SOC **3** was completed in 10 min to give **20** and **21** in 24% and 56% yields, respectively (Scheme 3). This behavior of **3** is very similar to that of SOE (Scheme 1). The less selectivity in this hydrolysis is in good accordance with the results of cationic ring-opening polymerization of **3** which afforded a mixture of poly(ether-carbonate) and polyether with the elimination of **21**.⁹⁾

In contrast to **3** USOC **4** having bidentate exomethylene groups was hydrolyzed to give only **24** via mode a. As shown in Scheme 4, decomposition of intermediate **23** take place via protonation of vinyl ether group followed by ring cleavage.

Experimental

Preparation of Spiroorthoester Derivatives. SOE **1** and USOEs (**2a**, **2b**, and **2c**) were prepared by the method reported earlier.^{7,16)}

2b: colorless liquid; bp 52–54 °C/0.4 mmHg (1 mmHg=133.322 Pa); IR (neat) 1693 (C=C), 1284, 1188, 1168, 1141, 1115, 1068, 1041, and 1018 cm⁻¹; ¹H NMR (CDCl₃) δ=4.7–4.3 (3H, m), 4.0–3.7 (3H, m), 2.1–1.8 (2H, m), 1.0–1.7 (3H, m), and 0.99 (3H, d, *J*=6.3 Hz); ¹³C NMR (CDCl₃) δ=155.3, (121.2*), 120.8, 79.7, (79.2*), (66.5*), 65.3, (64.5*), 64.4, 39.6, 32.8, (28.0*), 27.9, and 21.7 (*: chemical shift of

minor isomer); Anal. (C₉H₁₄O₃) C, H.

Preparation of Spiroorthocarbonate Derivatives. The preparation of **3**¹⁷ and **4**¹¹ was carried out according to the procedure reported previously.

Hydrolysis (General Procedure). A solution of spiro derivative and a few drops of aq HCl (6 mol dm⁻³) in THF or THF-H₂O were stirred at ambient temperature. The reaction was monitored by GC. The reaction mixture was quenched by adding a few drops of saturated aq NaHCO₃, dried over MgSO₄, and evaporated.

7a and 7b: separated by silica gel preparative TLC (ethyl acetate as eluent); quantitative yield; IR (neat) 3400 and 2940 cm⁻¹; ¹H NMR (CDCl₃) δ=4.23 (2H, d, J=7 Hz)*, 4.22 (2H, d, J=6 Hz)*, 4.08 (1H, m), 3.68 (2H, t, J=7 Hz), 3.64 (2H, d, J=6 Hz), 3.12 (1H, br s, -OH), 2.40 (2H, t, J=7 Hz)**, 2.32 (2H, t, J=7 Hz)**, 1.92 (1H, br s, -OH), and 1.2–1.8 (6H, m) (*, **: chemical shift of **7a** or **7b**). **12a:** colorless liquid, 15%; bp 125 °C/0.55 mmHg (Kugelrohr); IR (neat) 3400 and 1725 cm⁻¹; ¹H NMR (CDCl₃) δ=4.68 (2H, s), 3.68 (2H, t, J=6 Hz), 2.73 (1H, br s), 2.56 (2H, t, J=7 Hz), 2.17 (3H, s), and 1.91 (2H, tt, J=7 Hz, 6 Hz); ¹³C NMR (CDCl₃) δ=202.0, 173.1, 68.2, 61.4, 30.4, 27.6, and 26.0; HRMS Found: *m/z* 160.0730. Calcd for C₇H₁₂O₄: M, 160.0735. **12b:** colorless liquid; bp 150 °C/0.15 mmHg (Kugelrohr); IR (neat) 3450 and 1730 cm⁻¹; ¹H NMR (CDCl₃) δ=4.68 (2H, s), 3.69 (2H, t, J=6.6 Hz), 2.6–2.0 (4H, m), 2.17 (3H, s), 1.59 (2H, m), and 1.02 (3H, d, J=6.5 Hz); ¹³C NMR (CDCl₃) δ=201.7, 172.4, 68.1, 60.3, 41.2, 39.2, 27.1, 26.1, and 20.0; HRMS Found: *m/z* 188.10343. Calcd for C₉H₁₆O₄: M, 188.10485. **12c:** colorless liquid; bp 140 °C/0.09 mmHg (Kugelrohr); IR (neat) 3400 and 1730 cm⁻¹; ¹H NMR (CDCl₃) δ=4.67 (2H, s), 3.64 (2H, t, J=6 Hz), 2.46 (2H, t, J=7 Hz), 2.17 (3H, s), 2.13 (1H, s), and 1.9–1.2 (6H, m); ¹³C NMR (CDCl₃) δ=201.8, 173.0, 68.1, 62.4, 33.7, 32.2, 26.0, 25.2, and 24.5; HRMS Found: *m/z* 188.10537. Calcd for C₉H₁₆O₄: M, 188.10485. **20:** separated by silica-gel preparative TLC (hexane/ethyl acetate=2/8 in volume as eluent); colorless oil, 24%; bp 135 °C/0.12 mmHg (Kugelrohr); IR (neat) 3350 and 1740 cm⁻¹; ¹H NMR (CDCl₃) δ=4.30 (4H, m), 3.83 (4H, m), and 3.73 (2H, br s, -OH). **24:** colorless needle (recrystallized from CCl₄), 96%; mp 71–

71.5 °C; IR (KBr) 1766 and 1728 cm⁻¹; ¹H NMR (CDCl₃) δ=4.71 (4H, s) and 2.21 (6H, s); ¹³C NMR (CDCl₃) δ=201.1, 154.4, 71.3, and 26.0; Anal. (C₇H₁₀O₅) C, H.

References

- 1) K. Bodenbenner, *Justus Liebigs Ann. Chem.*, **625**, 183 (1959).
- 2) W. J. Bailey, R. L. Sun, H. Katsuki, T. Endo, H. Iwama, R. Tsushima, K. Saigo, and M. M. Bitritto, *ACS, Symp. Ser.*, **59**, 38 (1977).
- 3) S. Sakai, T. Fujinami, and S. Sakurai, *J. Polym. Sci., Polym. Lett. Ed.*, **11**, 631 (1973).
- 4) T. Endo and W. J. Bailey, *Makromol. Chem.*, **176**, 2897 (1975).
- 5) W. J. Bailey and T. Endo, *J. Polym. Sci., Polym. Chem. Ed.*, **14**, 1735 (1976).
- 6) T. Endo, H. Katsuki, and W. J. Bailey, *Makromol. Chem.*, **177**, 3231 (1976).
- 7) T. Endo, M. Okawara, and W. J. Bailey, *J. Polym. Sci., Polym. Chem. Ed.*, **19**, 1283 (1981).
- 8) T. Endo and W. J. Bailey, *J. Polym. Sci., Polym. Chem. Ed.*, **13**, 2525 (1975).
- 9) H. Fukuda, M. Hirota, T. Endo, M. Okawara, and W. J. Bailey, *J. Polym. Sci., Polym. Chem. Ed.*, **20**, 2935 (1982).
- 10) U. S. Etlis, F. N. Shomina, A. B. Buloviyatova, L. A. Tsareva, and E. G. Pomerantseva, *Polym. Sci., U. S. S. R.*, **25**, 857 (1983).
- 11) H. Tagoshi and T. Endo, *J. Polym. Sci., Part A; Polym. Chem.*, in press.
- 12) H. Tagoshi and T. Endo, *Chem. Lett.*, **1987**, 2363.
- 13) P. Deslongchamps, R. Chenevert, R. J. Taillefer, C. Moreau, and J. K. Saunders, *Can. J. Chem.*, **53**, 1601 (1975).
- 14) R. A. McClelland and C. Moreau, *Can. J. Chem.*, **63**, 2673 (1985).
- 15) R. A. McClelland and M. Alibhai, *Can. J. Chem.*, **59**, 1169 (1981).
- 16) T. Endo and W. J. Bailey, *J. Polym. Sci., Polym. Lett. Ed.*, **18**, 25 (1980).
- 17) T. Endo and M. Okawara, *Synthesis*, **1984**, 837.